

CATV VSB Filter For TV Modulator (PAL D/K)

Part Number ZCH5

Typical Performance

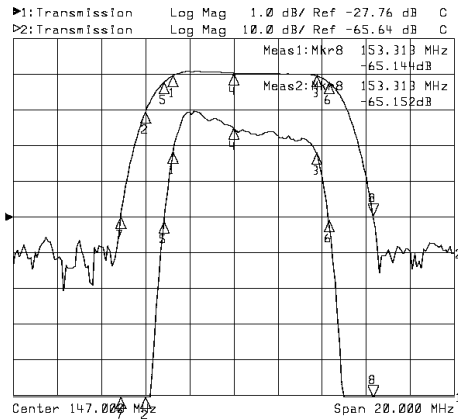

Horizontal: 2MHz/Div
Vertical: 1dB/Div&10dB/Div

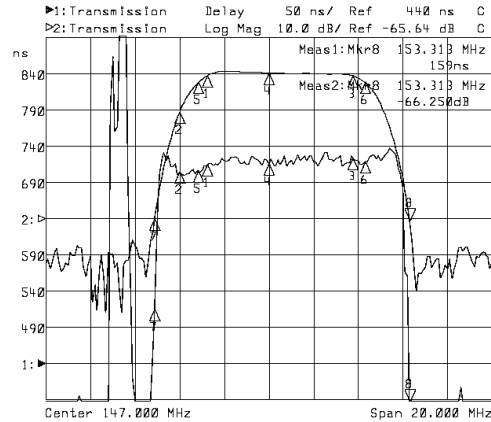

Horizontal: 2MHz/Div
Vertical: 50nsec/Div&10dB/Div

Specifications

Parameter	Unit	Minimum	Typical	Maximum
Center Frequency	MHz	146.90	147.00	147.10
Insertion Loss	dB		23.50	25.00
144.25MHz	dB		-1.00	-1.20
150.75MHz	dB		-1.00	-1.50
143.00MHz	dB	-15.00	-18.00	
Passband Variation	dB		0.80	1.00
Group Delay Variation	nsec		50	80
Absolute Delay	usec		0.71	0.73
Ultimate Rejection	dB	38	40	
Substrate Material	-		LiTaO3	
Ambient Temperature	°C	-40	25	80

Package SFA02

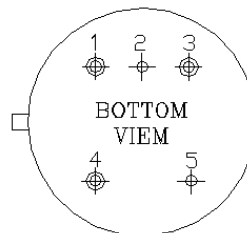
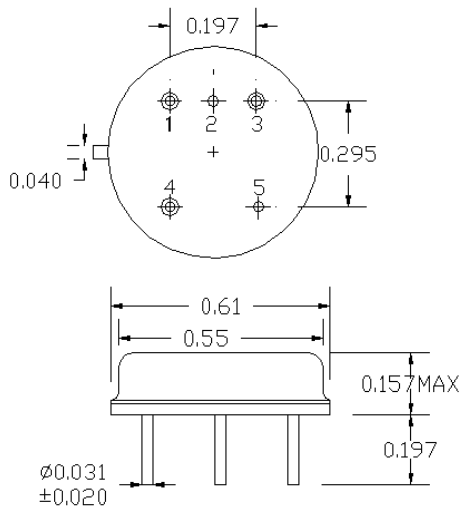

SFA02
 IN: 4
 OUT: 3
 GND: 1,2,5