

CATV VSB Filter For TV Modulator (PAL D/K)

Part Number ZCH4

Typical Performance

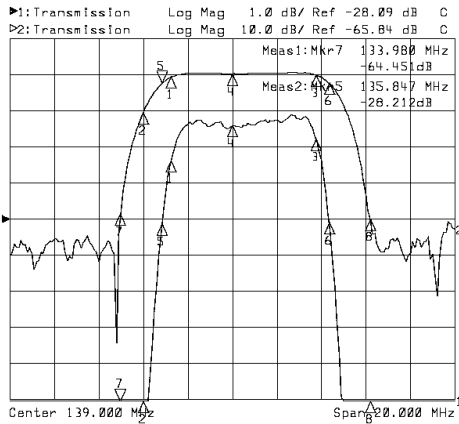

Horizontal: 2MHz/Div
Vertical: 1dB/Div&10dB/Div

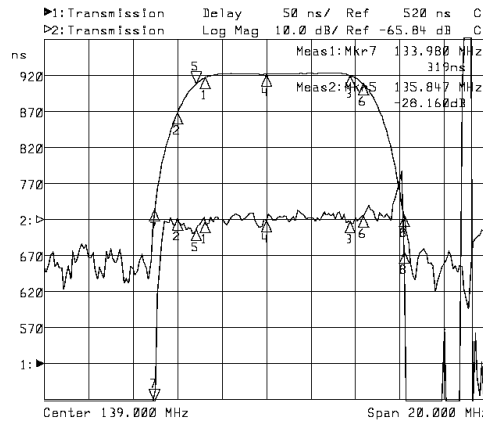

Horizontal: 2MHz/Div
Vertical: 50nsec/Div&10dB/Div

Specifications

Parameter	Unit	Minimum	Typical	Maximum
Center Frequency	MHz	138.90	139.00	139.10
Insertion Loss	dB		23.00	25.00
136.25MHz	dB		-1.00	-1.20
142.75MHz	dB		-1.00	-1.50
135.00MHz	dB	-12.00	-15.00	
Passband Variation	dB		0.60	0.80
Group Delay Variation	nsec		30	50
Absolute Delay	usec		0.70	0.80
Ultimate Rejection	dB	38	40	
Substrate Material	-		LiTaO3	
Ambient Temperature	°C	-40	25	80

Package SFA02

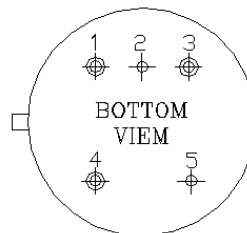
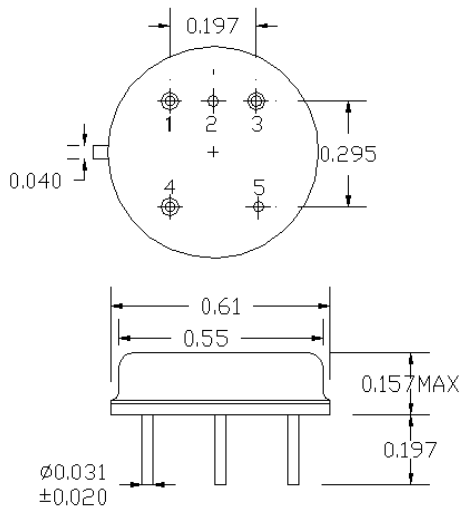

SFA02
 IN: 4
 OUT: 3
 GND: 1,2,5