

CATV VSB Filter For TV Modulator (PAL D/K)

Part Number ZCH2

Typical Performance

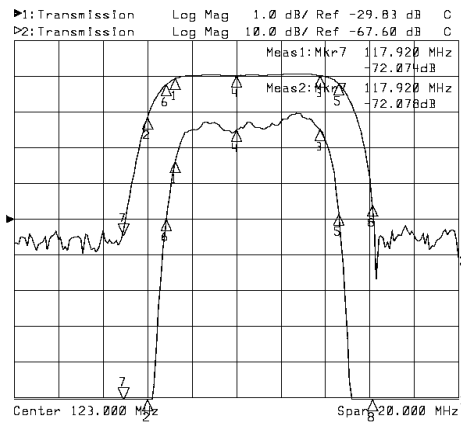

Horizontal: 2MHz/Div
Vertical: 1dB/Div&10dB/Div

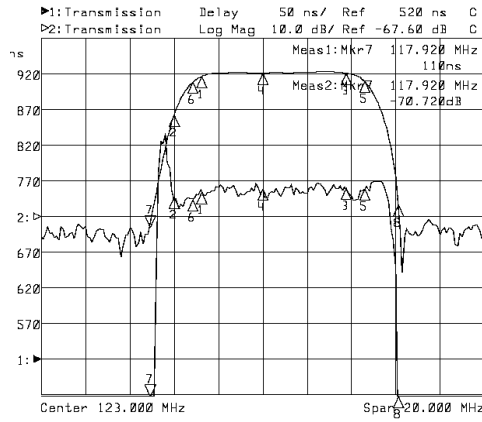

Horizontal: 2MHz/Div
Vertical: 50nsec/Div&10dB/Div

Specifications

Parameter	Unit	Minimum	Typical	Maximum
Center Frequency	MHz	122.90	123.00	123.10
Insertion Loss	dB		23.50	25.00
120.25MHz	dB		-1.00	-1.20
126.75MHz	dB		-1.20	-1.80
119.00MHz	dB	-12.00	-15.00	
Passband Variation	dB		1.00	1.20
Group Delay Variation	nsec		50	70
Absolute Delay	usec		0.70	0.72
Ultimate Rejection	dB	38	40	
Substrate Material	-		LiTaO3	
Ambient Temperature	°C	-40	25	80

Package SFA02

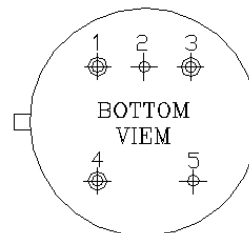
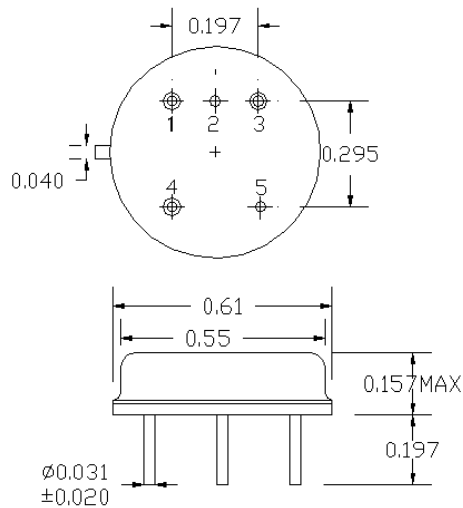

SFA02
 IN: 4
 OUT: 3
 GND: 1,2,5