

CATV VSB Filter For TV Modulator (PAL B/G)

Part Number S9

Typical Performance

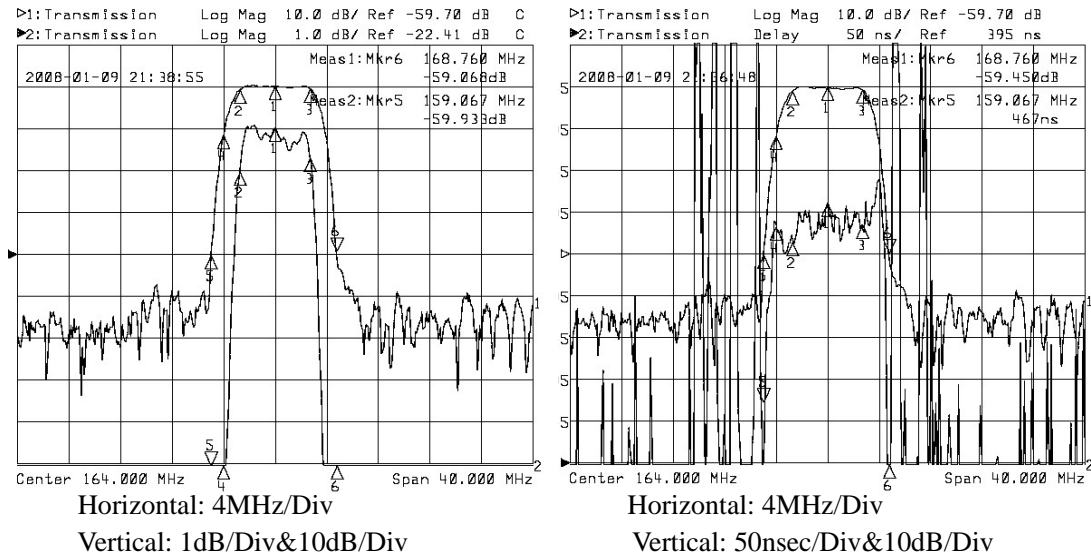

Specifications				
Parameter	Unit	Minimum	Typical	Maximum
Center Frequency	MHz	163.50	164.00	164.50
Insertion Loss	dB		19.50	21.00
161.25MHz	dB		-0.50	-1.00
166.75MHz	dB		-0.80	-1.50
159.75MHz	dB	-12.00	-16.00	
168.25MHz	dB	-13.00	-16.00	
Passband Variation	dB		0.50	1.00
Group Delay Variation	nsec		60	100
Absolute Delay	usec		0.70	
Ultimate Rejection	dB	48	50	
Substrate Material	-		LiTaO3	
Ambient Temperature	°C		25	
Package		SFA02		

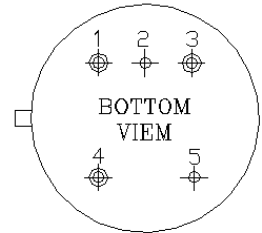
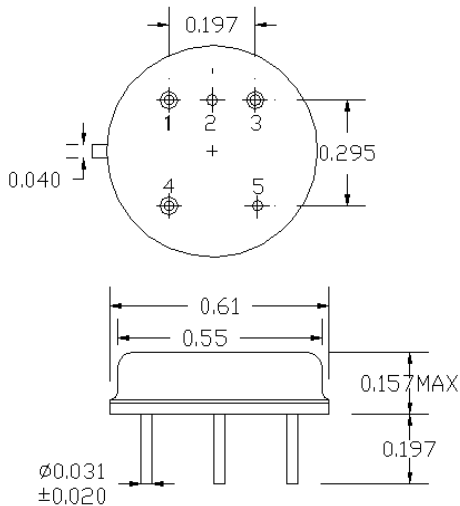

SFA02
 IN: 4
 OUT: 3
 GND: 1,2,5