

CATV VSB Filter For TV Modulator (PAL B/G)

Part Number S5

Typical Performance

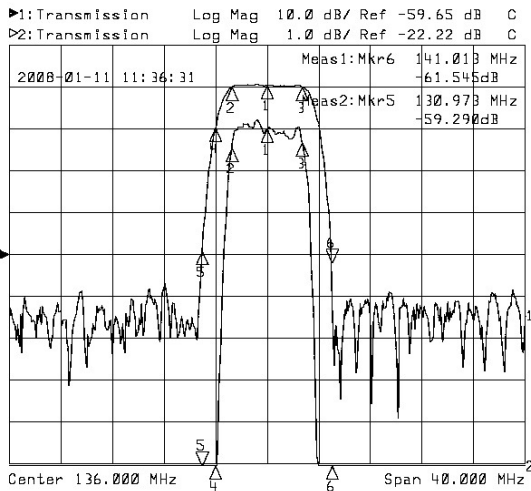

Horizontal: 4MHz/Div
Vertical: 1dB/Div&10dB/Div

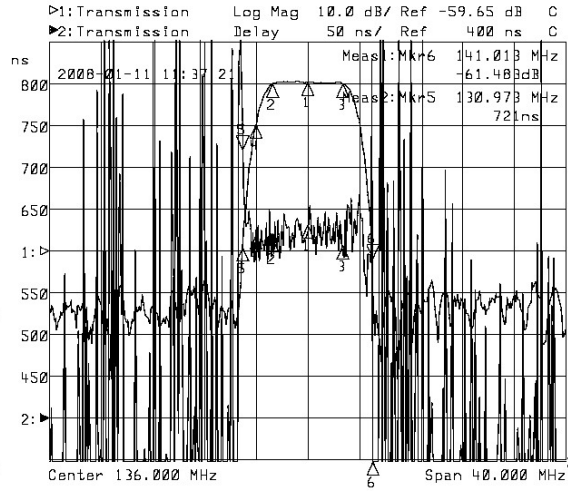

Horizontal: 4MHz/Div
Vertical: 50nsec/Div&10dB/Div

Specifications

Parameter	Unit	Minimum	Typical	Maximum
Center Frequency	MHz	135.50	136.00	136.50
Insertion Loss	dB		19.00	21.00
133.25MHz	dB		-0.50	-1.00
138.75MHz	dB		-0.80	-1.50
131.75MHz	dB	-9.00	-13.00	
140.25MHz	dB	-12.00	-15.00	
Passband Variation	dB		0.50	1.00
Group Delay Variation	nsec		50	100
Absolute Delay	usec		0.63	
Ultimate Rejection	dB	48	50	
Substrate Material	-		LiTaO3	
Ambient Temperature	°C		25	

Package SFA02

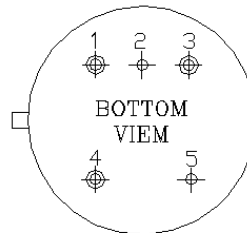
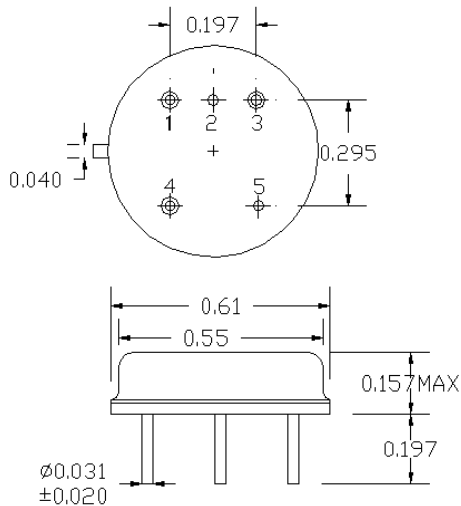

SFA02
IN: 4
OUT: 3
GND: 1,2,5