

CATV VSB Filter For TV Modulator (PAL B/G)

Part Number S2

Typical Performance

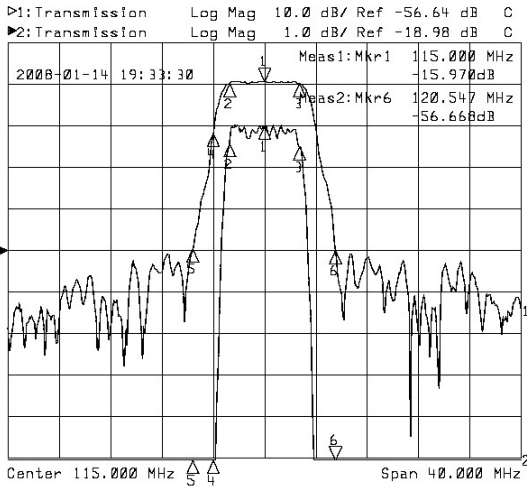

Horizontal: 4MHz/Div
Vertical: 1dB/Div&10dB/Div

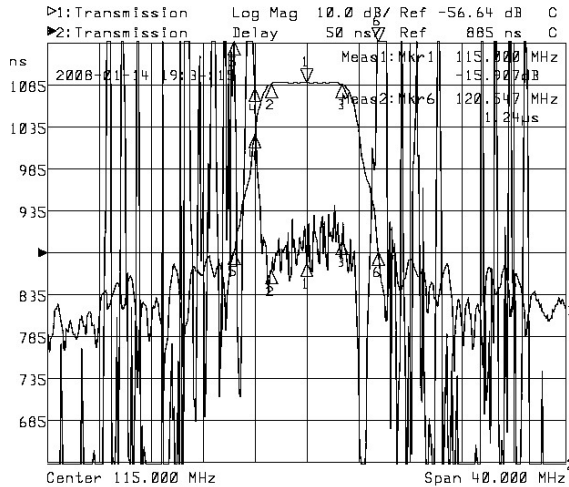

Horizontal: 4MHz/Div
Vertical: 50nsec/Div&10dB/Div

Specifications

Parameter	Unit	Minimum	Typical	Maximum
Center Frequency	MHz	114.50	115.00	115.50
Insertion Loss	dB		19.00	20.50
112.25MHz	dB		-0.70	-1.20
117.75MHz	dB		-0.80	-1.50
110.75MHz	dB	-12.00	-16.00	
119.25MHz	dB	-12.00	-16.00	
Passband Variation	dB		0.50	1.00
Group Delay Variation	nsec		80	100
Absolute Delay	usec		0.87	
Ultimate Rejection	dB	40	42	
Substrate Material	-		128-LiNbO3	
Ambient Temperature	°C		25	

Package SFA02

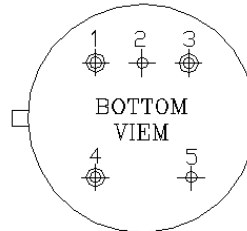
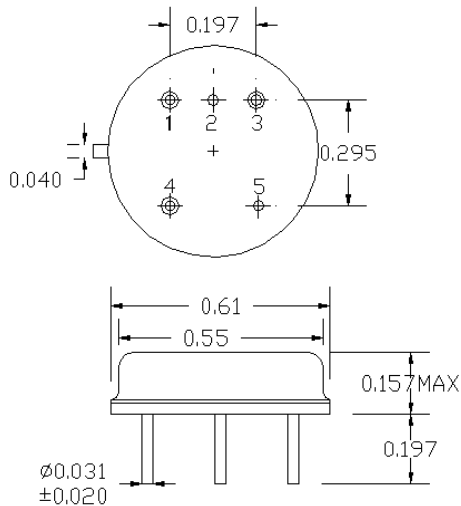

SFA02
IN: 4
OUT: 3
GND: 1,2,5