

CATV VSB Filter For TV Modulator (PAL B/G)

Part Number S10

Typical Performance

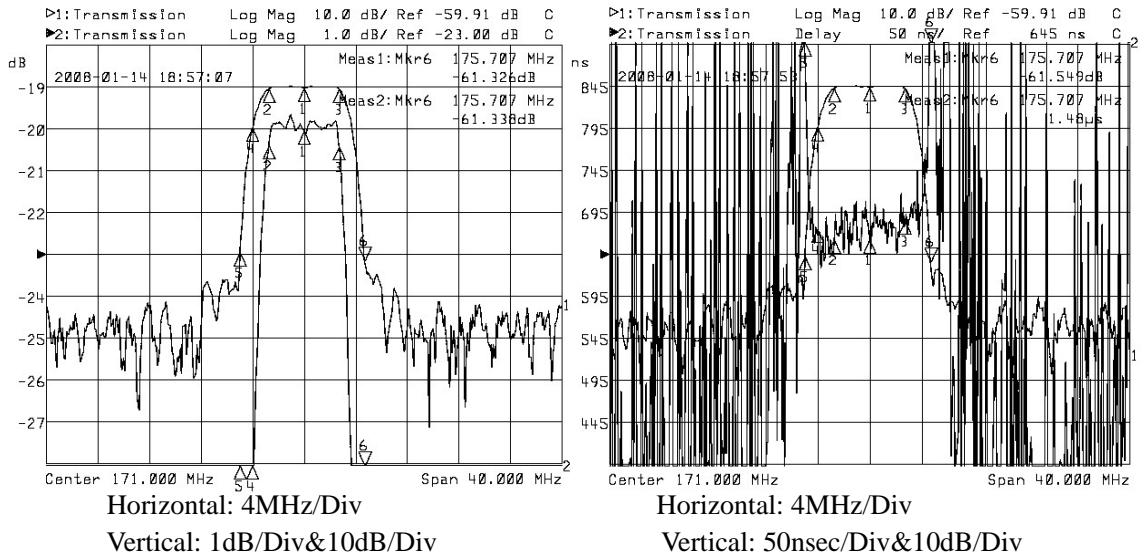

Specifications				
Parameter	Unit	Minimum	Typical	Maximum
Center Frequency	MHz	170.50	171.00	171.50
Insertion Loss	dB		20.00	21.00
168.25MHz	dB		-0.50	-1.00
173.75MHz	dB		-0.80	-1.50
166.75MHz	dB	-12.00	-16.00	
175.25MHz	dB	-15.00	-18.00	
Passband Variation	dB		0.50	1.00
Group Delay Variation	nsec		70	100
Absolute Delay	usec		0.66	
Ultimate Rejection	dB	42	45	
Substrate Material	-		LiTaO3	
Ambient Temperature	°C		25	
Package		SFA02		

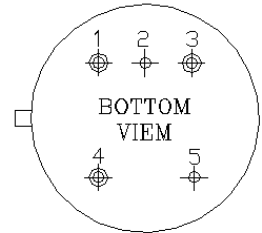
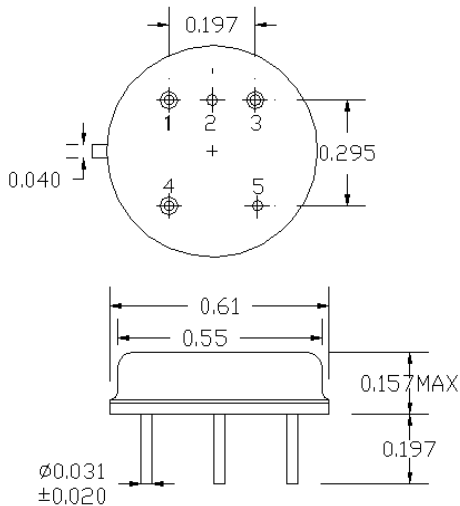

SFA02
 IN: 4
 OUT: 3
 GND: 1,2,5