

CATV VSB Filter For TV Modulator (PAL B/G)

Part Number P3

Typical Performance

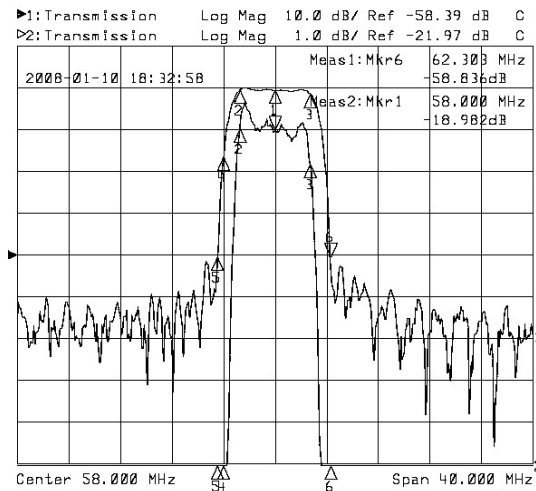

Horizontal: 4MHz/Div
Vertical: 1dB/Div&10dB/Div

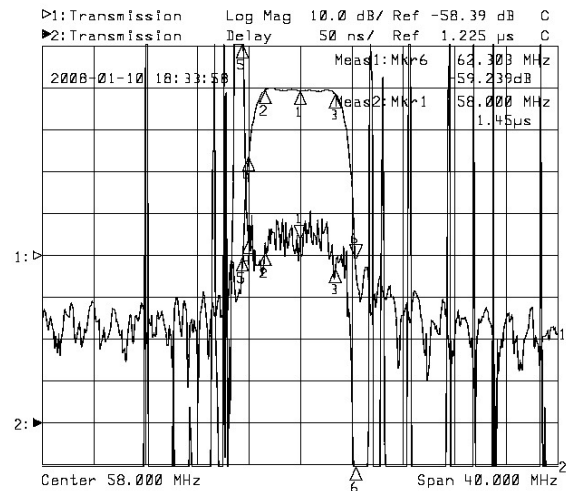

Horizontal: 4MHz/Div
Vertical: 50nsec/Div&10dB/Div

Specifications				
Parameter	Unit	Minimum	Typical	Maximum
Center Frequency	MHz	57.50	58.00	58.50
Insertion Loss	dB		19.00	20.50
55.25MHz	dB		-0.50	-1.00
60.75MHz	dB		-0.50	-1.50
53.75MHz	dB	-18.00	-20.00	
62.25MHz	dB	-18.00	-20.00	
Passband Variation	dB		0.70	1.00
Group Delay Variation	nsec		40	80
Absolute Delay	usec		1.45	
Ultimate Rejection	dB	40	42	
Substrate Material	-		128-LiNbO3	
Ambient Temperature	°C		25	
Package		SFA02		

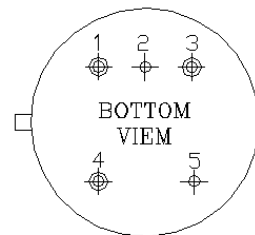
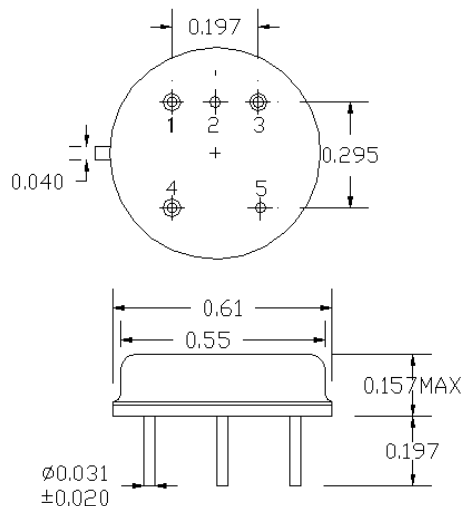

SFA02
 IN: 4
 OUT: 3
 GND: 1,2,5