

CATV VSB Filter For TV Modulator (PAL B/G)

Part Number P12

Typical Performance

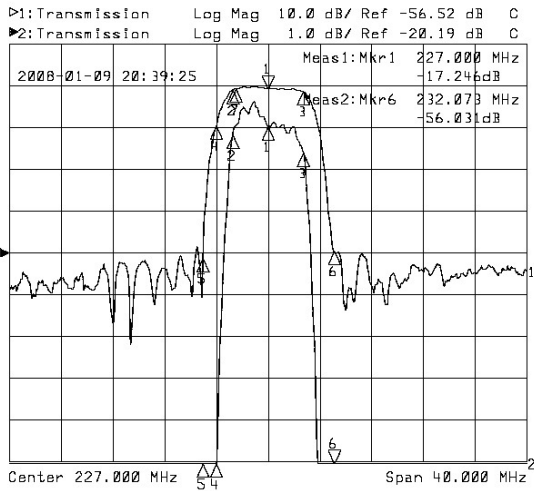

Horizontal: 4MHz/Div
Vertical: 1dB/Div&10dB/Div

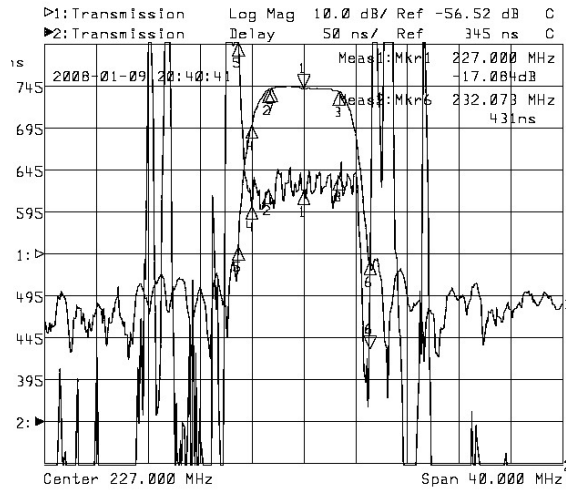

Horizontal: 4MHz/Div
Vertical: 50nsec/Div&10dB/Div

Specifications

Parameter	Unit	Minimum	Typical	Maximum
Center Frequency	MHz	226.50	227.00	227.50
Insertion Loss	dB		17.50	20.50
224.25MHz	dB		-0.50	-1.00
229.75MHz	dB		-0.70	-1.50
222.75MHz	dB	-8.00	-10.00	
231.25MHz	dB	-12.00	-16.00	
Passband Variation	dB		0.70	1.00
Group Delay Variation	nsec		50	100
Absolute Delay	usec		0.62	
Ultimate Rejection	dB	40	42	
Substrate Material	-		LiTaO3	
Ambient Temperature	°C		25	

Package SFA02

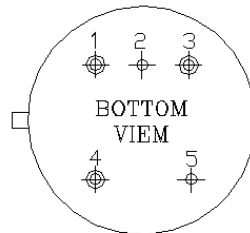
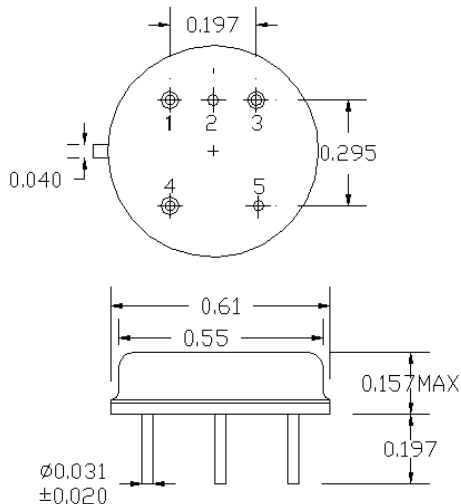

SFA02
 IN: 4
 OUT: 3
 GND: 1,2,5