

# CATV VSB Filter For TV Modulator (PAL B/G)

## Part Number P11

### Typical Performance

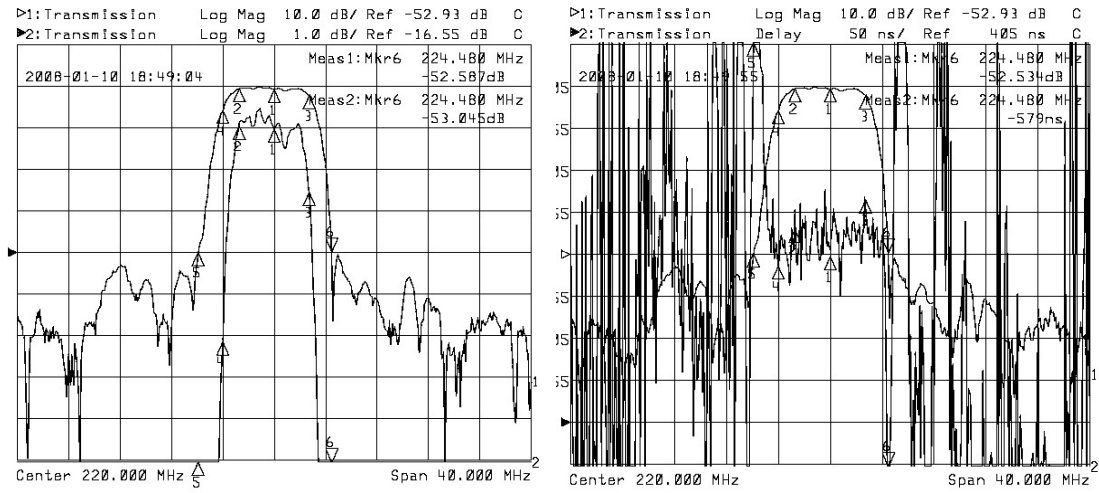

Horizontal: 4MHz/Div  
Vertical: 1dB/Div&10dB/Div

Horizontal: 4MHz/Div  
Vertical: 50nsec/Div&10dB/Div

Specifications				
Parameter	Unit	Minimum	Typical	Maximum
Center Frequency	MHz	219.50	220.00	220.50
Insertion Loss	dB		17.50	20.50
217.25MHz	dB		-0.50	-1.00
222.75MHz	dB		-1.00	-1.50
215.75MHz	dB	-10.00	-13.00	
224.25MHz	dB	-10.00	-14.00	
Passband Variation	dB		0.70	1.00
Group Delay Variation	nsec		120	170
Absolute Delay	usec		0.60	
Ultimate Rejection	dB	40	42	
Substrate Material	-		LiTaO3	
Ambient Temperature	°C		25	
<b>Package</b>		<b>SFA02</b>		

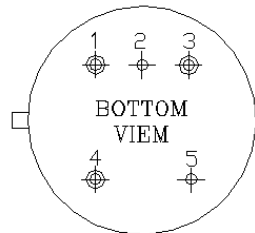
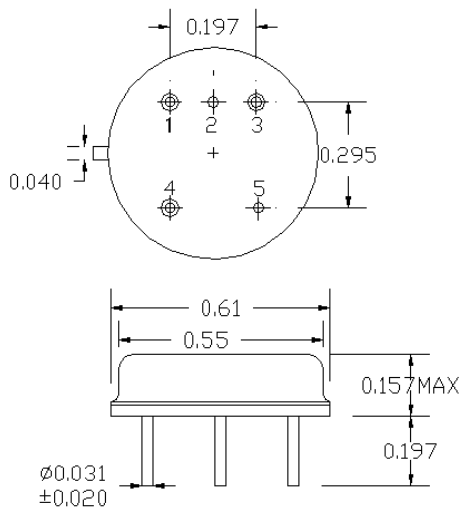

SFA02  
 IN: 4  
 OUT: 3  
 GND: 1,2,5