

CATV VSB Filter For TV Modulator (PAL B/G)

Part Number P10

Typical Performance

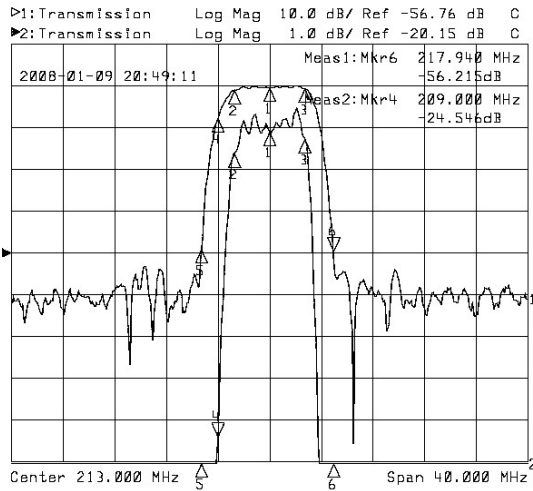

Horizontal: 4MHz/Div
Vertical: 1dB/Div&10dB/Div

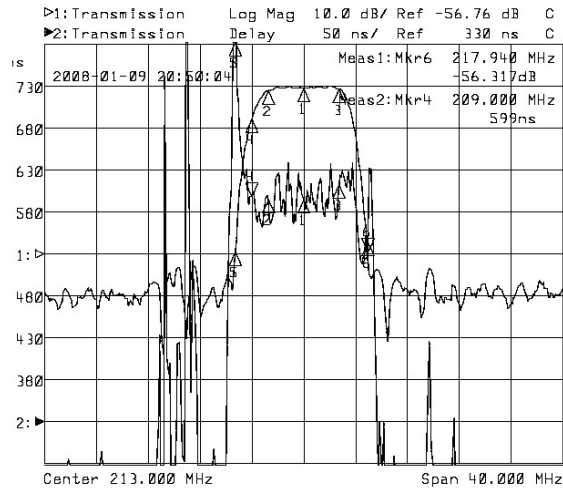

Horizontal: 4MHz/Div
Vertical: 50nsec/Div&10dB/Div

Specifications

Parameter	Unit	Minimum	Typical	Maximum
Center Frequency	MHz	212.50	213.00	213.50
Insertion Loss	dB		19.50	21.00
210.25MHz	dB		-0.50	-1.00
215.75MHz	dB		-0.80	-1.50
208.75MHz	dB	-8.00	-12.00	
217.25MHz	dB	-8.00	-12.00	
Passband Variation	dB		0.40	1.00
Group Delay Variation	nsec		50	100
Absolute Delay	usec		0.60	
Ultimate Rejection	dB	42	45	
Substrate Material	-		LiTaO3	
Ambient Temperature	°C		25	

Package SFA02

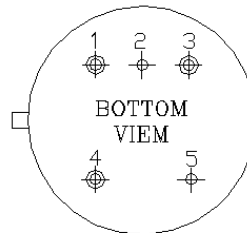
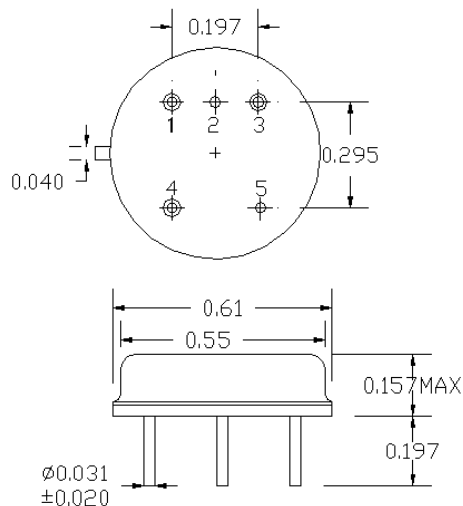

SFA02
 IN: 4
 OUT: 3
 GND: 1,2,5