

CATV VSB Filter For TV Modulator (PAL D/K)

Part Number CH3B

Typical Performance

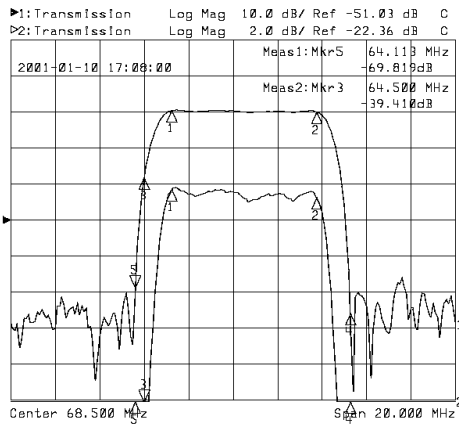

Horizontal: 2MHz/Div
Vertical: 1dB/Div&10dB/Div

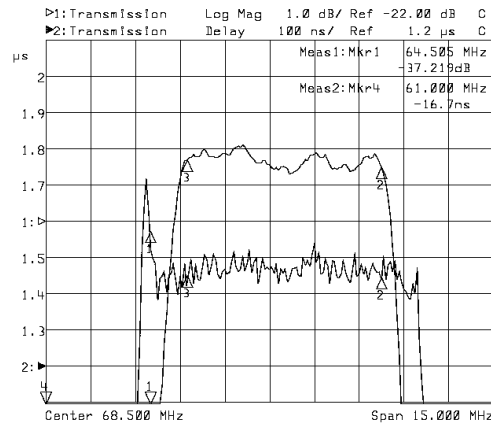

Horizontal: 1.5MHz/Div
Vertical: 100nsec/Div&10dB/Div

Specifications

Parameter	Unit	Minimum	Typical	Maximum
Center Frequency	MHz	68.00	68.50	69.00
Insertion Loss	dB		20.00	22.00
65.75MHz	dB		-0.50	-1.00
72.25MHz	dB		-0.50	-1.00
64.50MHz	dB	-18.00	-20.00	
Passband Variation	dB		0.50	1.00
Group Delay Variation	nsec		60	100
Absolute Delay	usec		1.51	1.53
Ultimate Rejection	dB	45	48	
Substrate Material	-		128-LiNbO3	
Ambient Temperature	°C	-40	25	80

Package SFA02

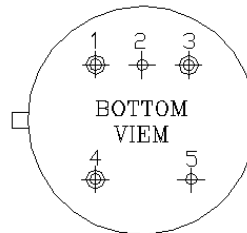
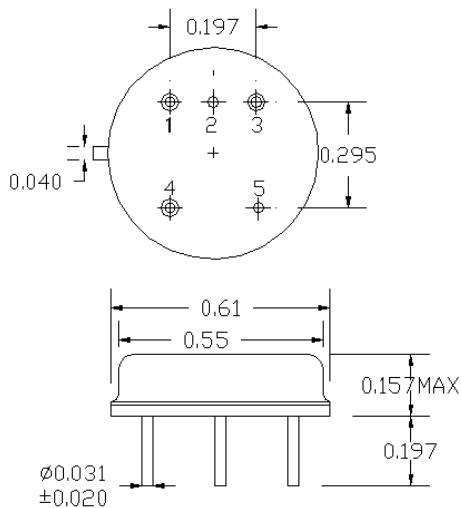

SFA02
 IN: 4
 OUT: 3
 GND: 1,2,5