

# CATV VSB Filter For TV Modulator (PAL D/K)

## Part Number CH2B

### Typical Performance

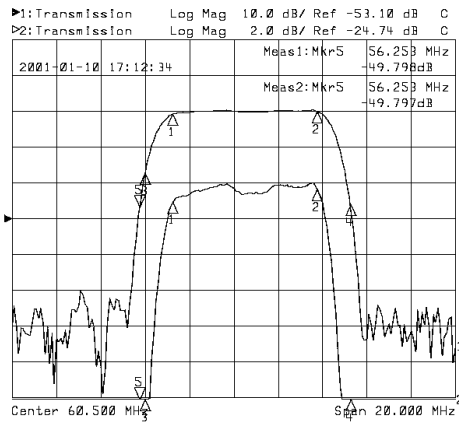

Horizontal: 2MHz/Div  
Vertical: 1dB/Div&10dB/Div

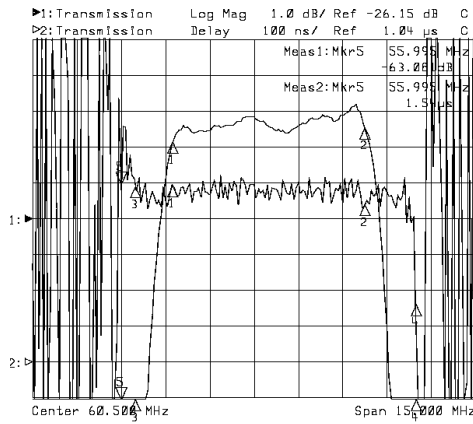

Horizontal: 1.5MHz/Div  
Vertical: 100nsec/Div&10dB/Div

### Specifications

Parameter	Unit	Minimum	Typical	Maximum
Center Frequency	MHz	60.00	60.50	61.00
Insertion Loss	dB		22.00	24.00
57.75MHz	dB		-0.50	-1.20
64.25MHz	dB		-0.50	-1.20
56.5MHz	dB	-15.00	-18.00	
Passband Variation	dB		0.50	1.00
Group Delay Variation	nsec		60	80
Absolute Delay	usec		1.50	1.52
Ultimate Rejection	dB	45	50	
Substrate Material	-		128-LiNbO3	
Ambient Temperature	°C	-40	25	80

### Package SFA02

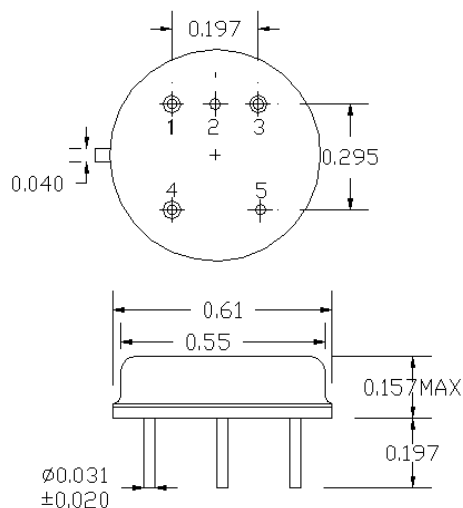

SFA02  
IN: 4  
OUT: 3  
GND: 1,2,5