

CATV VSB Filter For TV Modulator(PAL D/K)

Part Number CH1B

Typical Performance

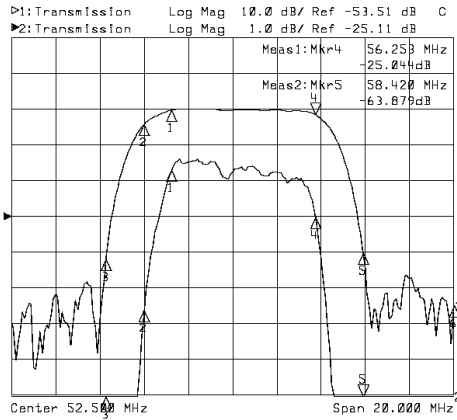

Horizontal: 2MHz/Div
Vertical: 1dB/Div&10dB/Div

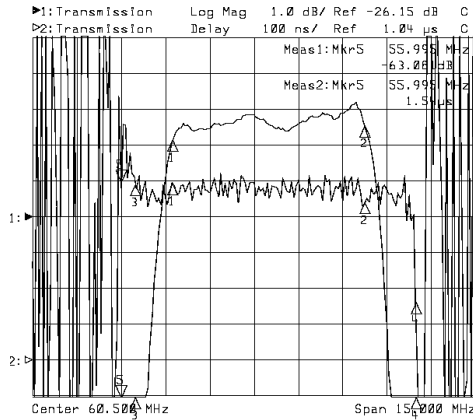

Horizontal: 1.5MHz/Div
Vertical: 100nsec/Div&10dB/Div

Specifications

Parameter	Unit	Minimum	Typical	Maximum
Center Frequency	MHz	52.00	52.50	53.00
Insertion Loss	dB		24.00	25.00
49.75MHz	dB		-0.50	-1.00
56.25MHz	dB		-1.20	-1.80
48.50MHz	dB	-10.00	-12.00	
Passband Variation	dB		0.80	1.00
Group Delay Variation	nsec		40	80
Absolute Delay	usec		1.50	1.52
Ultimate Rejection	dB	45	50	
Substrate Material	-		128-LiNbO3	
Ambient Temperature	°C	-40	25	80

Package SFA02

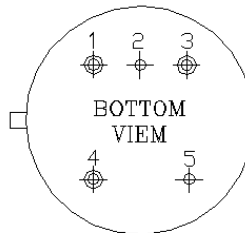
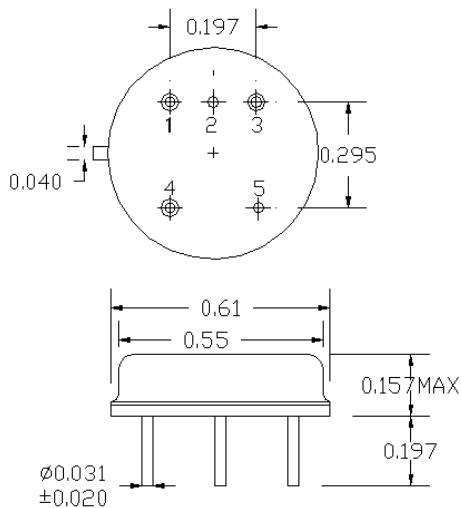

SFA02
 IN: 4
 OUT: 3
 GND: 1,2,5