

CATV VSB Filter For TV Modulator (PAL D/K)

Part Number CH11B

Typical Performance

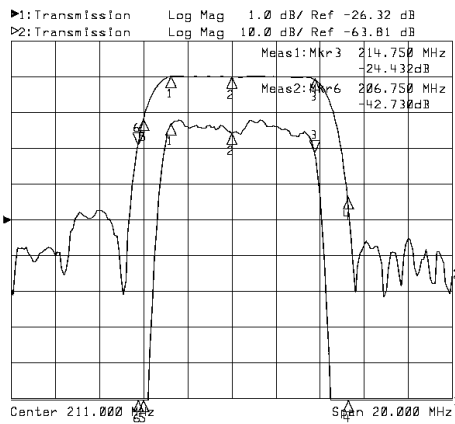

Horizontal: 2MHz/Div
Vertical: 1dB/Div&10dB/Div

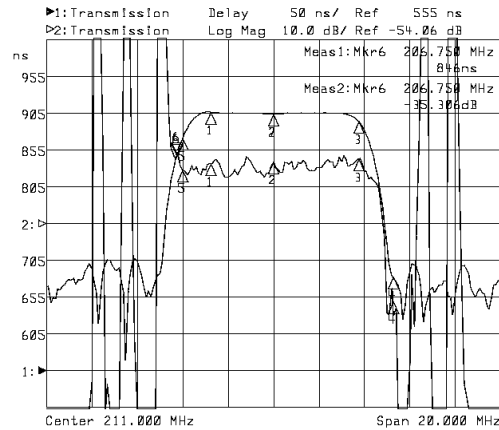

Horizontal: 2MHz/Div
Vertical: 50nsec/Div&10dB/Div

Specifications

Parameter	Unit	Minimum	Typical	Maximum
Center Frequency	MHz	210.90	211.00	211.10
Insertion Loss	dB		20.00	22.00
208.25MHz	dB		-0.80	-1.50
214.75MHz	dB		-0.80	-1.50
207.00MHz	dB	-11.00	-14.00	
Passband Variation	dB		0.80	1.00
Group Delay Variation	nsec		40	60
Absolute Delay	usec		0.70	0.72
Ultimate Rejection	dB	38	40	
Substrate Material	-		128-LiNbO3	
Ambient Temperature	°C	-40	25	80

Package SFA02

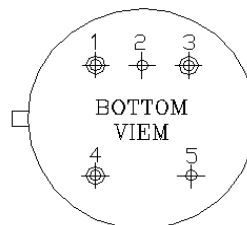
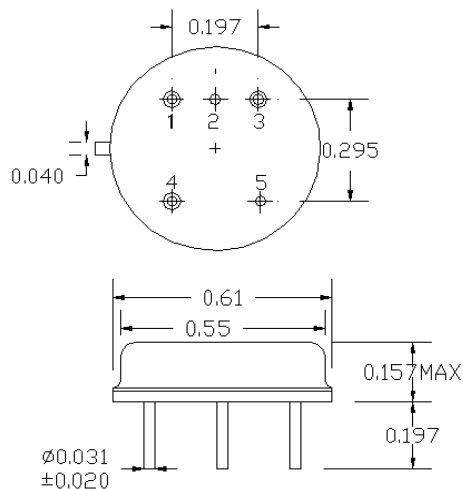

SFA02
 IN: 4
 OUT: 3
 GND: 1,2,5